

VUEPOINT™

Assembly Instructions for Model: FPM255

Thank you for choosing a VUEPOINT™ Wall Mount. This product is designed to mount flat panel televisions up to 50" [1270 mm] and weighing up to 130 lbs [59 kg] only 1.25" [31.75 mm] off the wall.

▲ CAUTION: The size and weight of your large screen television must not exceed 50" [1270 mm] diagonally and 130 Lbs [59 Kg]. The wall must be capable of supporting five times the weight of the television plus the wall mount. Never use defective parts. Improper installation may cause property damage or personal injury. Do not use this product for any purpose that is not explicitly specified by Sanus Systems.

If you do not understand these directions, or have any doubts about the safety of the installation, please call a qualified contractor or contact CSAV at 800.359.5520 or www.vuepointav.com. Our customer service representatives can quickly assist you with installation questions and missing or damaged parts. Replacement parts for products purchased through authorized dealers will be shipped directly to you. Check carefully to make sure that there are no missing or defective parts. CSAV can not be liable for damage or injury caused by incorrect mounting, incorrect assembly, or incorrect use. Please call CSAV before returning products to the point of purchase.

NOTE: The supplied wall mounting hardware is not for metal stud or old cinder block walls. If you are uncertain about the nature of your wall, consult an installation contractor. CSAV makes every effort to assure all necessary television mounting hardware is included. If the hardware you need is not included, please consult your local hardware store or call CSAV.

Required Tools: Drill, 3/16" drill bit, 1/2" masonry bit for brick, concrete, or concrete block installations, wrench or socket set, phillips screwdriver.

Supplied Parts and Hardware: (All threaded fasteners are shown full size.)

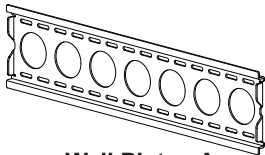

Wall Plate - A
Qty. 1



Safety Bar - B
Qty. 1

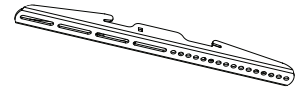

Monitor Bracket - C
Qty. 2

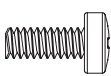

M4 x 12 Bolt - D
Qty. 4

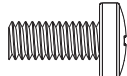

M5 x 12 Bolt - E
Qty. 4

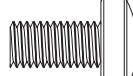

M6 x 12 Bolt - F
Qty. 4

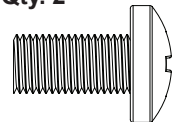

M8 x 16 Bolt - G
Qty. 4

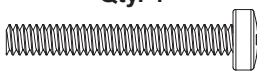

M4 x 30 Bolt - H
Qty. 4



M5 x 30 Bolt - I
Qty. 4



M6 x 35 Bolt - J
Qty. 4



M8 x 40 Bolt - K
Qty. 4



M4 Lock Washer - L
Qty. 4



M5 Lock Washer - M
Qty. 4



M6 Lock Washer - N
Qty. 4



M8 Lock Washer - O
Qty. 4

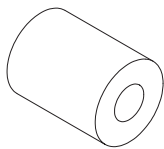

M4/M5 Spacer - P
Qty. 4

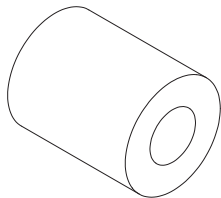

M6/M8 Spacer - Q
Qty. 4

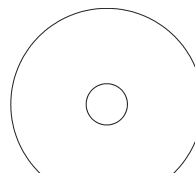

M4/M5 Washer - R
Qty. 8

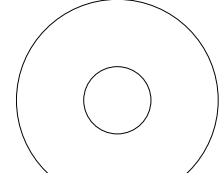

M6/M8 Washer - S
Qty. 4

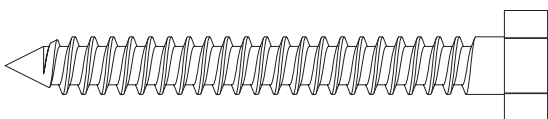

Lag Bolt - T
Qty. 6

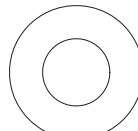

Lag Bolt Washer - U
Qty. 6

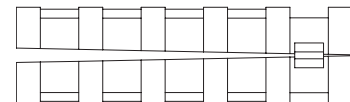

Concrete Anchor - V
Qty. 6

Step 1: Mount Monitor Brackets to a television with a flat back

NOTE: For televisions with a curved back, or an obstruction near the threaded insert proceed directly to Step 2.

Determine the diameter of the Bolt (**D,E,F,G**) your TV requires by hand threading them into the threaded insert on the back of the TV. If you encounter any resistance stop immediately.

Once you have determined the correct diameter Bolt (**D,E,F,G**), see the appropriate Diagram below, thread the Bolt through the appropriate Lock Washer (**L,M,N,O**), the corresponding Washer (**R,S**), the Monitor Bracket (**C**), and into the TV.

Make sure the Monitor Brackets (**C**) are vertically centered and level with each other.

Tighten the Bolts (**D,E,F,G**) securing the Monitor Brackets (**C**) to the TV.

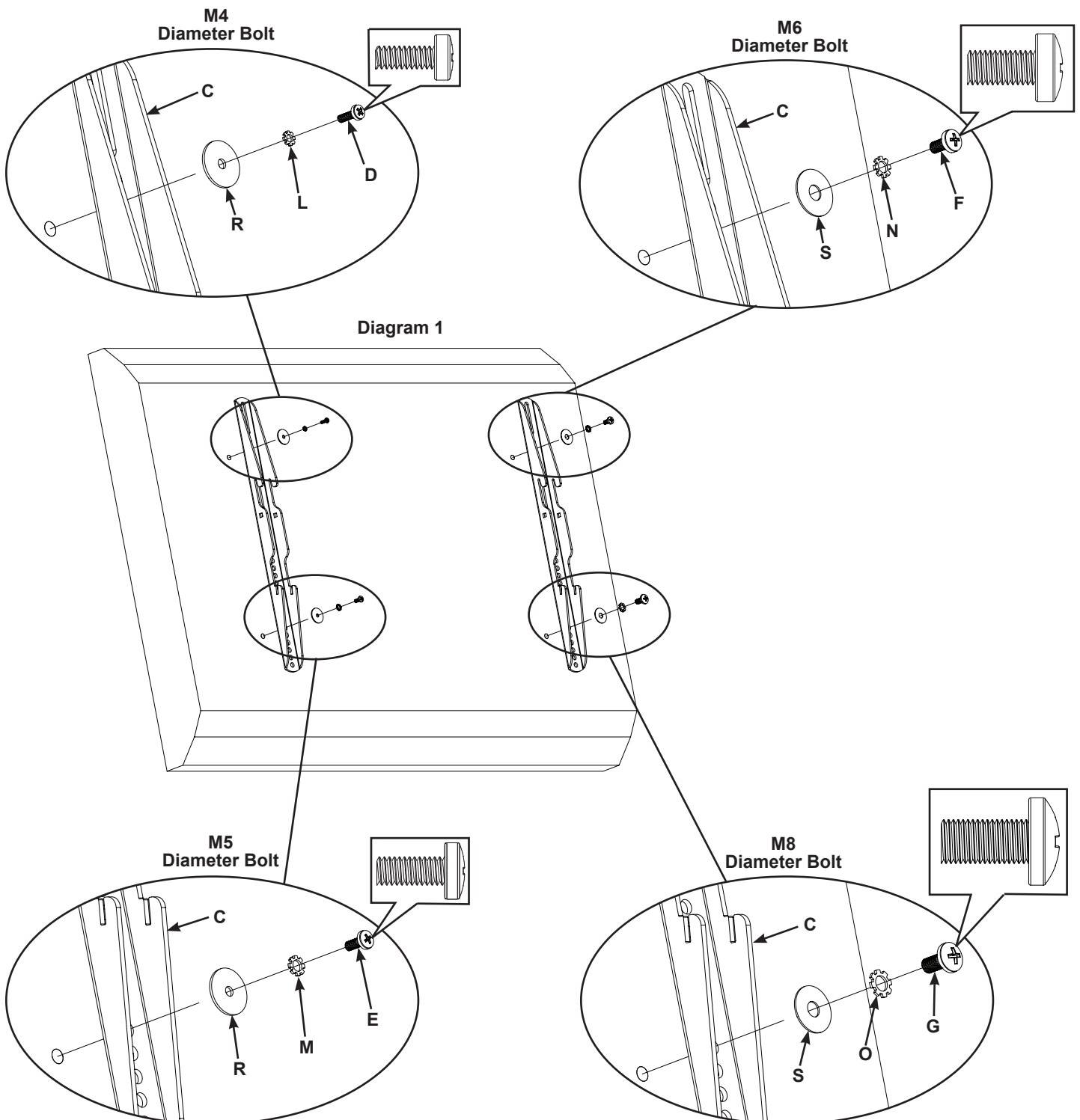

Step 2: Mount Monitor Brackets to a television curved back or an obstruction near the threaded insert.

Determine the diameter of the Bolt (H,I,J,K) your TV requires by hand threading them into the threaded insert on the back of the TV. If you encounter any resistance stop immediately.

Once you have determined the correct diameter Bolt (H,I,J,K), see the appropriate Diagram below, thread the Bolt through the appropriate Lock Washer (L,M,N,O), the corresponding Washer (R,S), the Monitor Bracket (C), Spacer (P,Q), a second Washer (R - M4/M5 Diameter Bolts only) and into the TV.

Make sure the Monitor Brackets (C) are vertically centered and level with each other.

Tighten the Bolts (H,I,J,K) securing the Monitor Brackets (C) to the TV.

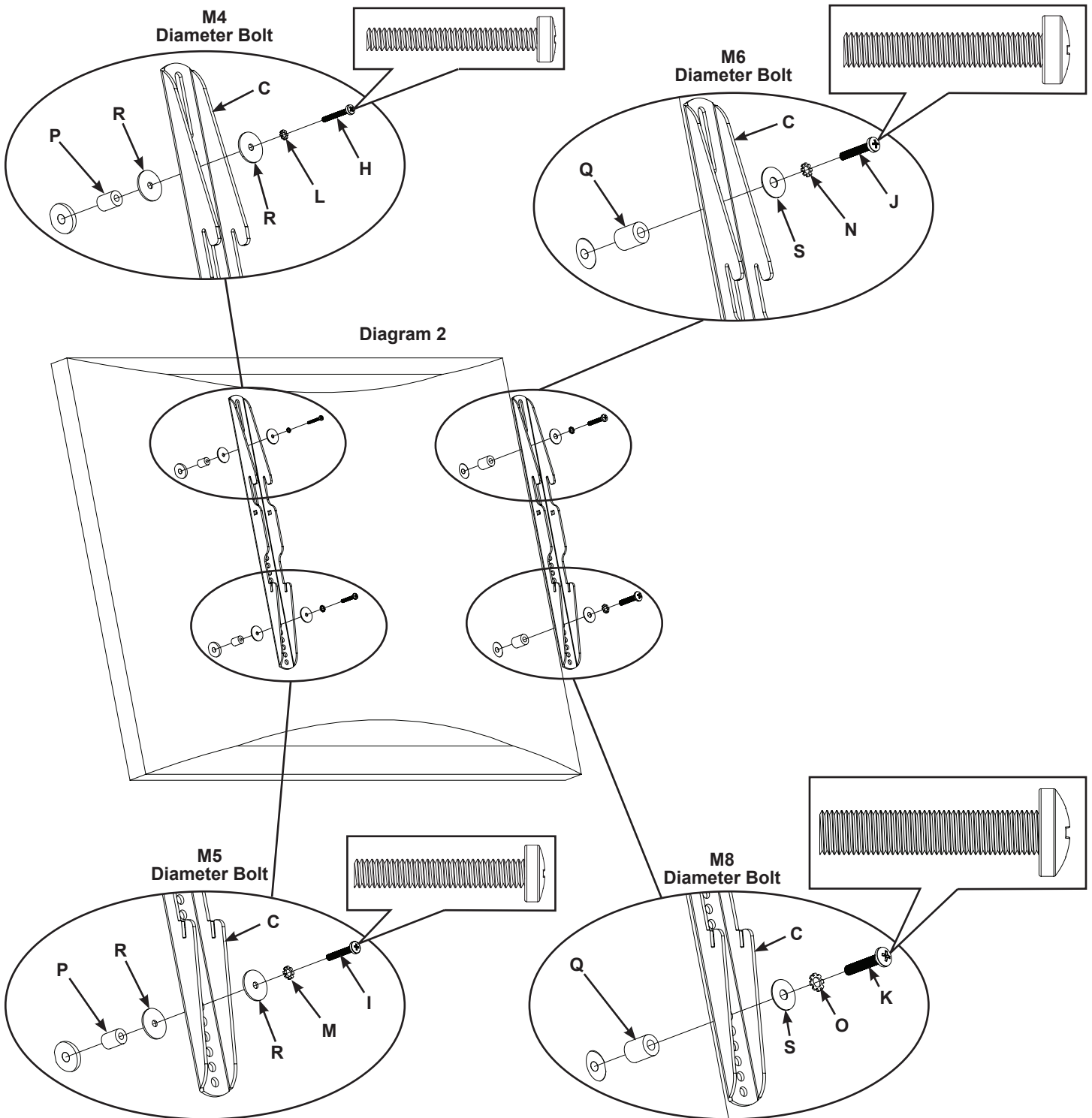

Step 3: Mounting the Wall Plate

Wood Stud Mounting

▲ CAUTION: Do not over tighten the Lag Bolts. Tighten Lag Bolts (T) only until the Lag Bolt Washer (U) is pulled firmly against the Wall Plate (A). If there is a layer of drywall or other material, this drywall or other material may not exceed 5/8 inch [15.8 mm] in thickness. Failure to heed this caution may result property damage and/or personal injury

NOTE: The Wall Plate (A) must be mounted on two wood studs at least 12" [304.8 mm] apart.

Use a high quality stud sensor to locate two adjacent studs. It is recommended that you verify the stud locations with an awl or nail. Pre-drill a hole 2.5" [63.5 mm] deep into the studs using a 3/16" drill bit. Make sure these holes are centered in the studs and level with each other. Using the Wall Plate (A) as a template, mark the corresponding location for the bottom holes in each stud, and drill holes 2.5" [63.5 mm] deep at these locations. Orient the Wall Plate with its flat surface against the wall, and using the four Lag Bolts (T) and Lag Bolt Washers (U), secure the Wall Plate to the wall as shown in Diagram 3A.

Brick, Solid Concrete, or Concrete Block Mounting

▲ CAUTION: Always locate Concrete Anchors (V) in the brick, block, or concrete. Never drill into the mortar between blocks. Make sure the Concrete Anchor is seated flush with the concrete surface even if there is a layer of drywall or other material. This drywall or other material may not exceed 5/8 inch [15.8 mm] in thickness. Failure to heed this caution may result property damage and/or personal injury.

Using the Wall Plate (A) as a template, mark six hole locations on the wall, with the outer holes as far to the edges of the Wall Plate as possible. These holes must be level and there must be a minimum of 6" [152.4 mm] between each hole. Pre-drill these holes at least 2.5" [63.5 mm] deep using a 1/2" masonry bit. Insert a Concrete Anchor (V) into each hole, making sure they are completely seated and flush with the concrete surface, even if there is a layer of drywall or other material in front of the concrete. Attach the Wall Plate using six Lag Bolts (T) and Lag Bolt Washers (U) as shown in Diagram 3B.

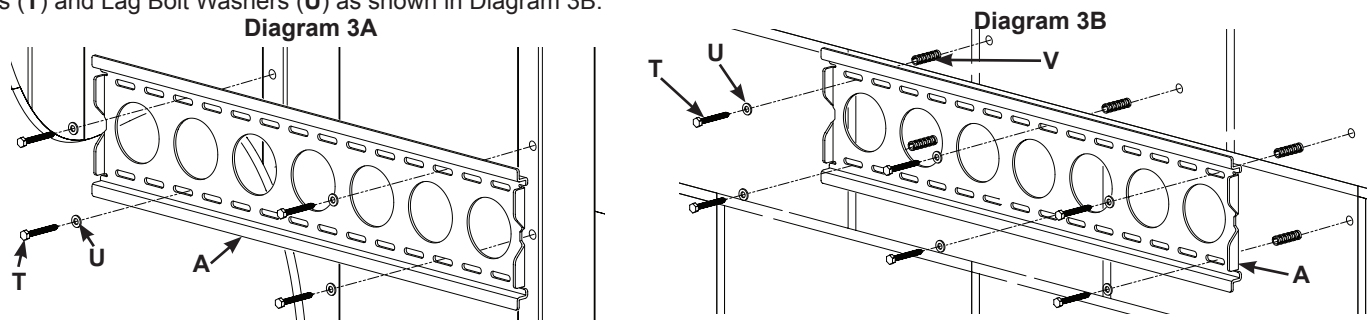

Step 4: Hang the TV onto the Wall Plate

Hook the Monitor Brackets (C) over the top of the Wall Plate (A); then, let the bottom of the Monitor Brackets rotate in under the bottom of the Wall Plate as shown in Diagram 4A. Insert the Safety bar (B) into the slots in the bottom of the Monitor Brackets so that it sits behind the bottom tab of the Wall Plate as shown in Diagram 4B. The bend in the end of the Safety Bar should face toward the wall. Once the Safety Bar passes out the other side of the Wall Plate, a padlock (purchased separately) can be added to the hole in the Safety Bar for additional security.

